

## Features

- Low peak clamping voltage even during severe current surges
- Ability to repeatedly protect against high surge currents up to rated limits
- Convenient mounting and grounding to any flat surface or to DIN-1 (TS-32) or DIN-3 (TS-35) rail
- Cable shields are passed through and may be either grounded or arc-protected to ground
- Vibration-resistant screw-type clamp terminals
- Flame-resistant epoxy-filled housing

## 1840 Series – Signal and Dataline Protector

The Bourns® 1840 Series Signal and Dataline Protectors are designed to protect sensitive electronic circuits and components from damaging surge voltages and currents. Their extremely fast response and low clamping voltages make them particularly suitable for the protection of sensitive signal and datalines associated with computer, data communication, instrumentation, broadcasting and industrial controls. They may be used directly with EIA standard interfaces RS-232, RS-422, RS-423, RS-485 and with 4-20 mA and 50 mA instrumentation loops. The Model 1840 Series Signal and Dataline Protectors are fast, rugged and capable of protecting against fast rising voltage transients as well as the severe current surges associated with lightning discharges, in each case up to rated limits.

### Method of Operation

The Bourns® 1840 Series are heavy-duty, multi-staged protectors. A solid-state 3rd stage protection component intercepts the leading edge of the surge within sub-nanosecond response time. Within microseconds, a primary stage 3-electrode common chambered heavy-duty gas discharge tube capable of handling 20,000 ampere lightning currents operates and crowbars the majority of the surge energy to ground. The Model 1840 also utilizes Bourns' TBU® High-Speed Protector (HSP) technology as a key 2nd stage. Any current through the protector exceeding 300 mA will cause the TBU® HSP to quickly transition into a high impedance state, thus isolating any harmful voltage and/or current from damaging the protected equipment. The gas discharge tube protector remains in the crowbar state until the surge has passed and line voltages return to safe levels. The TBU® HSP then automatically restores the line to normal operation by resetting to a low impedance state. There is no need for resetting a breaker or replacing a fuse to address a transient surge event.

### Application

Protectors are generally placed at each end of a signal, dataline or current loop. In the case of daisy-chain configurations (such as RS-485), protectors are placed at each node.

### Related Bourns® Protectors

For outdoor applications with 1/2-inch NPT ports (such as field-mounted 4-20 mA transmitters), please refer to the Bourns® Model 1669 Series Protector. In this application, the mixed use of a Model 1840 Series Protector at the controller and a Model 1669 Series Protector at the field is recommended.

### Characteristics @ 25 °C

Standard Model	1840-05	1840-12	1840-24
Maximum Operating Voltage	6 V <sub>dc</sub>	13 V <sub>dc</sub>	26 V <sub>dc</sub>
Maximum Breakdown Voltage (L-L) and (L-G)	8 V <sub>dc</sub>	15 V <sub>dc</sub>	30 V <sub>dc</sub>

### Surge Life

100 Amps 10 x 1000 μsec.....	300 operations min.
100 Amps 10 x 1000 μsec.....	300 operations min.
500 Amps 10 x 1000 μsec.....	50 operations min.
1000 Amps 10 x 1000 μsec.....	10 operations min.
3 kA, 6 kV / 8 x 20 μsec Combination Wave.....	100 operations min.
10 kA / 8 x 20 μsec.....	10 operations min.
20 kA / 8 x 20 μsec.....	5 operations min.
Breakdown Voltage.....	See table*
ESD @ 8 kV.....	10 operations min.
Shield ARC Protection 6 kV / 3 kA.....	5 operations min.
Capacitance @ 1 MHz.....	L/G: 45 pF, L/L: 35 pF
Series Resistance.....	12 Ω typical
Maximum Load Continuous Current.....	220 mA
DC Leakage Current at Rated L/G Voltage.....	< 10 μA
Blocking Current.....	300 mA; typical 450 mA
Signal/Data Attenuation.....	3 db @ 30 MHz with 50 Ω termination
Operating Temperature.....	-40 °C to +60 °C
Response Time.....	< 1 μsec
Wire Size.....	20 AWG

\*Custom voltages are available upon request. Please visit [www.bourns.com/data/global/pdfs/SMBJ.pdf](http://www.bourns.com/data/global/pdfs/SMBJ.pdf) for custom allowable voltage. Lead-time may be extended for some custom voltages.

### Circuit Diagram

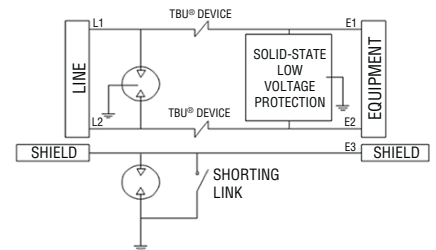

**BOURNS®**

### Asia-Pacific:

Tel: +886-2 2562-4117  
Fax: +886-2 2562-4116

### EMEA:

Tel: +36 88 520 390  
Fax: +36 88 520 211

### The Americas:

Tel: +1-951 781-5500  
Fax: +1-951 781-5700

[www.bourns.com](http://www.bourns.com)

Specifications are subject to change without notice.

The device characteristics and parameters in this data sheet can and do vary in different applications and actual device performance may vary over time. Users should verify actual device performance in their specific applications.

# 1840 Series – Signal and Dataline Protector

**BOURNS®**

## Typical Connections

### Unbalanced Interface, Two Individual Circuits, Such as RS-232

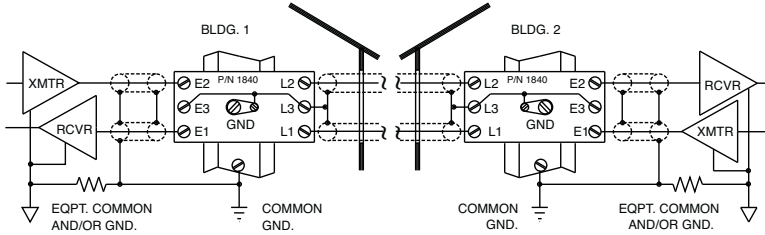

### Balanced or Differential Interface, Such as RS-422

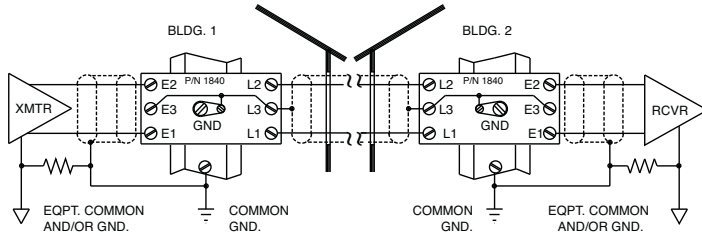

### Current Loop, 4-20 mA

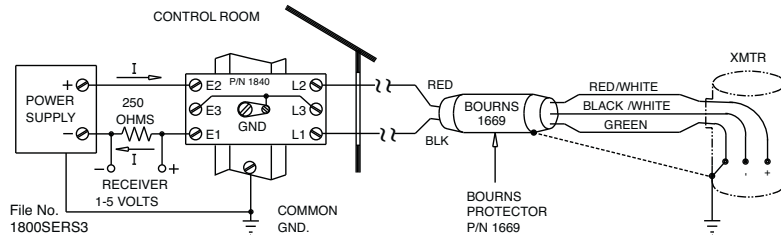

**Grounding:** The 8-32 mounting screw and attached clamp, and hence the DIN-1 (TS-32) or DIN-3 (TS-35) rail, serve as the protector ground. The rail (or 8-32 mounting screw if the clamp is not used) should be connected to the facility ground via an AWG #6 or larger copper wire. This wire should be as short and straight as possible. Single point grounding will provide better protection and will permit the protector to be located a distance from the equipment.

## How To Order

Model No. Designator **1840 - nn - An**

Voltage  
 05 = 5 V<sub>dc</sub>  
 12 = 12 V<sub>dc</sub>  
 24 = 24 V<sub>dc</sub>

Clamp  
 A1 = DIN-1  
 A3 = DIN-3

## How To Order (Clamp)

Add -A1 to base model number for DIN-1 clamp.

(Example: 1840-12-A1)

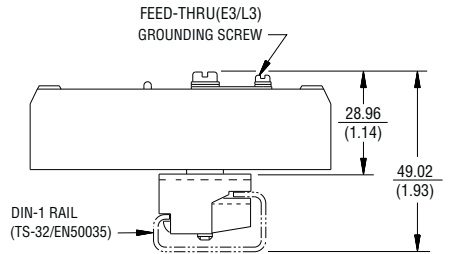

Add -A3 to base model number for DIN-3 clamp.

(Example: 1840-12-A3)

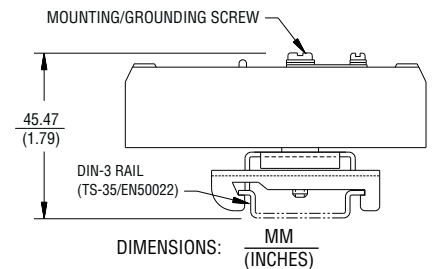

## Product Dimensions

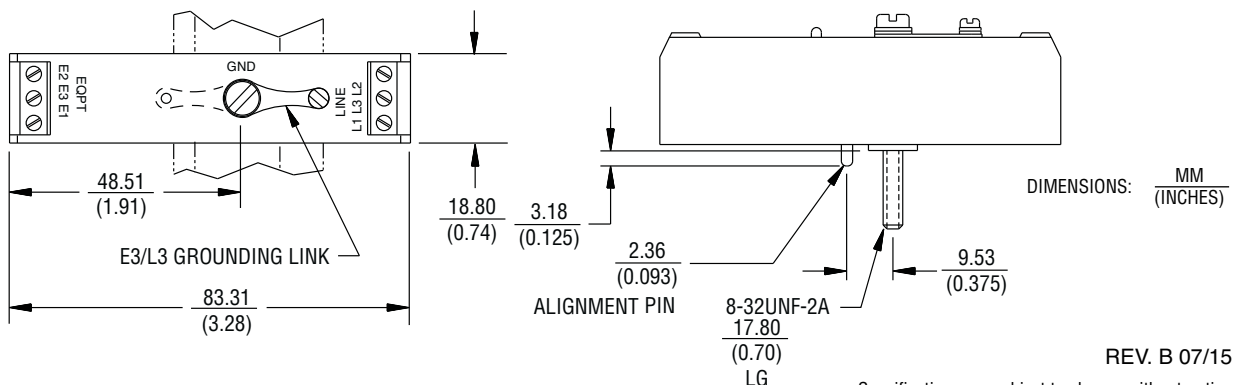

REV. B 07/15

Specifications are subject to change without notice. The device characteristics and parameters in this data sheet can and do vary in different applications and actual device performance may vary over time. Users should verify actual device performance in their specific applications.

# Mouser Electronics

Authorized Distributor

Click to View Pricing, Inventory, Delivery & Lifecycle Information:

Bourns:

[1840-05-A3](#) [1840-05-A1](#) [1840-24-A3](#) [1840-12-A1](#) [1840-12-A3](#) [1840-24-A1](#)