

Features

- 650 V enhancement mode power switch
- Bottom-side cooled configuration
- $R_{DS(on)} = 25 \text{ m}\Omega$
- $I_{DS(max)} = 60 \text{ A}$
- Ultra-low FOM Island Technology® die
- Low inductance GaN_{px}® package
- Easy gate drive requirements (0 V to 6 V)
- Transient tolerant gate drive (-20 / +10 V)
- Very high switching frequency (> 10 MHz)
- Fast and controllable fall and rise times
- Reverse current capability
- Zero reverse recovery loss
- Small 11 x 9 mm² PCB footprint
- Source Sense (SS) pads for optimized gate drive
- Dual gate and source sense pads for optimal board layout
- RoHS 6 compliant

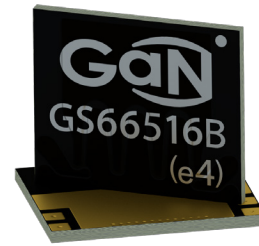

Package Outline

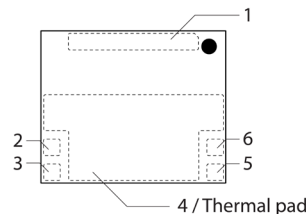

Circuit Symbol

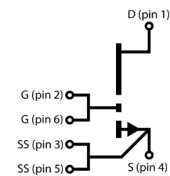

Applications

- High efficiency power conversion
- High density power conversion
- AC-DC Converters
- Bridgeless Totem Pole PFC
- ZVS Phase Shifted Full Bridge
- Half Bridge topologies
- Synchronous Buck or Boost
- Uninterruptable Power Supplies
- Industrial Motor Drives
- Single and 3Φ inverter legs
- Solar and Wind Power
- Fast Battery Charging
- DC-DC converters
- On Board Battery Chargers
- Traction Drive

Description

The GS66516B is an enhancement mode gallium nitride (GaN) on silicon power transistor. The properties of GaN allow for high current, high voltage breakdown and high switching frequency. GaN Systems implements patented **Island Technology**® cell layout for high-current die performance & yield. **GaN_{px}**® packaging enables low inductance & low thermal resistance in a small package. The GS66516B is a bottom-side cooled transistor that offers very low junction-to-case thermal resistance for demanding high power applications. These features combine to provide very high efficiency power switching.

Absolute Maximum Ratings ($T_{case} = 25\text{ }^{\circ}\text{C}$ except as noted)

| Parameter | Symbol | Value | Unit |
|--|---------------------|-------------|--------------------|
| Operating Junction Temperature | T_J | -55 to +150 | $^{\circ}\text{C}$ |
| Storage Temperature Range | T_S | -55 to +150 | $^{\circ}\text{C}$ |
| Drain-to-Source Voltage | V_{DS} | 650 | V |
| Transient Drain-to-Source Voltage (note 1) | $V_{DS(transient)}$ | 750 | V |
| Gate-to-Source Voltage | V_{GS} | -10 to +7 | V |
| Gate-to-Source Voltage - transient (note 1) | $V_{GS(transient)}$ | -20 to +10 | V |
| Continuous Drain Current ($T_{case}=25\text{ }^{\circ}\text{C}$) (note 2) | I_{DS} | 60 | A |
| Continuous Drain Current ($T_{case}=100\text{ }^{\circ}\text{C}$) (note 2) | I_{DS} | 47 | A |

(1) Pulse $\leq 1\text{ }\mu\text{s}$.

(2) Limited by saturation.

Thermal Characteristics (Typical values unless otherwise noted)

| Parameter | Symbol | Min. | Typ. | Max. | Units |
|---|-----------------|------|------|------|-----------------------------|
| Thermal Resistance (junction-to-case) | $R_{\theta JC}$ | | 0.27 | | $^{\circ}\text{C}/\text{W}$ |
| Thermal Resistance (junction-to-top) | $R_{\theta JT}$ | | 5.5 | | $^{\circ}\text{C}/\text{W}$ |
| Thermal Resistance (junction-to-ambient) (note 3) | $R_{\theta JA}$ | | 23 | | $^{\circ}\text{C}/\text{W}$ |
| Maximum Soldering Temperature (MSL3 rated) | T_{SOLD} | | | 260 | $^{\circ}\text{C}$ |

(3) Device mounted on 1.6 mm PCB thickness FR4, 4-layer PCB with 2 oz. copper on each layer. The recommendation for thermal vias under the thermal pad are 0.3 mm diameter (12 mil) with 0.635 mm pitch (25 mil). The copper layers under the thermal pad and drain pad are 25 x 25 mm² each. The PCB is mounted in horizontal position without air stream cooling.

Ordering Information

| Part number | Package type | Ordering code | Packing method | Quantity |
|-------------|-------------------------------------|---------------|----------------|----------|
| GS66516B | GaN [®] Bottom-Side Cooled | GS66516B-TR | Tape-and-reel | 2000 |
| GS66516B | GaN [®] Bottom-Side Cooled | GS66516B-MR | Mini-reel | 250 |

Electrical Characteristics (Typical values at $T_J = 25\text{ }^\circ\text{C}$, $V_{GS} = 6\text{ V}$ unless otherwise noted)

| Parameters | Sym. | Min. | Typ. | Max. | Units | Conditions |
|---|--------------|------|------|------|---------------|---|
| Drain-to-Source Blocking Voltage | BV_{DS} | 650 | | | V | $V_{GS} = 0\text{ V}$, $I_{DSS} = 100\text{ }\mu\text{A}$ |
| Drain-to-Source On Resistance | $R_{DS(on)}$ | | 25 | 32 | m Ω | $V_{GS} = 6\text{ V}$, $T_J = 25\text{ }^\circ\text{C}$, $I_{DS} = 18\text{ A}$ |
| Drain-to-Source On Resistance | $R_{DS(on)}$ | | 65 | | m Ω | $V_{GS} = 6\text{ V}$, $T_J = 150\text{ }^\circ\text{C}$, $I_{DS} = 18\text{ A}$ |
| Gate-to-Source Threshold | $V_{GS(th)}$ | 1.1 | 1.3 | | V | $V_{DS} = V_{GS}$, $I_{DS} = 14\text{ mA}$ |
| Gate-to-Source Current | I_{GS} | | 320 | | μA | $V_{GS} = 6\text{ V}$, $V_{DS} = 0\text{ V}$ |
| Gate Plateau Voltage | V_{plat} | | 3.0 | | V | $V_{DS} = 400\text{ V}$, $I_{DS} = 60\text{ A}$ |
| Drain-to-Source Leakage Current | I_{DSS} | | 4 | 100 | μA | $V_{DS} = 650\text{ V}$, $V_{GS} = 0\text{ V}$, $T_J = 25\text{ }^\circ\text{C}$ |
| Drain-to-Source Leakage Current | I_{DSS} | | 800 | | μA | $V_{DS} = 650\text{ V}$, $V_{GS} = 0\text{ V}$, $T_J = 150\text{ }^\circ\text{C}$ |
| Internal Gate Resistance | R_G | | 0.34 | | Ω | $f = 1\text{ MHz}$, open drain |
| Input Capacitance | C_{ISS} | | 520 | | pF | $V_{DS} = 400\text{ V}$, $V_{GS} = 0\text{ V}$, $f = 1\text{ MHz}$ |
| Output Capacitance | C_{OSS} | | 130 | | pF | |
| Reverse Transfer Capacitance | C_{RSS} | | 4 | | pF | |
| Effective Output Capacitance, Energy Related (note 4) | $C_{O(ER)}$ | | 177 | | pF | $V_{GS} = 0\text{ V}$, $V_{DS} = 0\text{ to }400\text{ V}$ |
| Effective Output Capacitance, Time Related (note 5) | $C_{O(TR)}$ | | 284 | | pF | |
| Total Gate Charge | Q_G | | 12.1 | | nC | $V_{GS} = 0\text{ to }6\text{ V}$, $V_{DS} = 400\text{ V}$ |
| Gate-to-Source Charge | Q_{GS} | | 4.4 | | nC | |
| Gate-to-Drain Charge | Q_{GD} | | 3.4 | | nC | |
| Output Charge | Q_{OSS} | | 113 | | nC | $V_{GS} = 0\text{ V}$, $V_{DS} = 400\text{ V}$ |
| Reverse Recovery Charge | Q_{RR} | | 0 | | nC | |

(4) $C_{O(ER)}$ is the fixed capacitance that would give the same stored energy as C_{OSS} while V_{DS} is rising from 0 V to the stated V_{DS} .

(5) $C_{O(TR)}$ is the fixed capacitance that would give the same charging time as C_{OSS} while V_{DS} is rising from 0 V to the stated V_{DS} .

Electrical Characteristics continued (Typical values at $T_J = 25\text{ }^\circ\text{C}$, $V_{GS} = 6\text{ V}$ unless otherwise noted)

| Parameters | Sym. | Min. | Typ. | Max. | Units | Conditions |
|----------------------------------|--------------|------|-------|------|---------------|---|
| Turn-On Delay | $t_{D(on)}$ | | 4.6 | | ns | $V_{DD} = 400\text{ V}$, $V_{GS} = 0 - 6\text{ V}$, $I_D = 16\text{ A}$, $R_{G(ext)} = 5\ \Omega$, $T_J = 25\text{ }^\circ\text{C}$ (note 6) |
| Rise Time | t_R | | 12.4 | | ns | |
| Turn-Off Delay | $t_{D(off)}$ | | 14.9 | | ns | |
| Fall Time | t_F | | 22 | | ns | |
| Output Capacitance Stored Energy | E_{OSS} | | 14.1 | | μJ | $V_{DS} = 400\text{ V}$, $V_{GS} = 0\text{ V}$, $f = 1\text{ MHz}$ |
| Switching Energy during turn-on | E_{on} | | 134.1 | | μJ | $V_{DS} = 400\text{ V}$, $I_{DS} = 20\text{ A}$, $V_{GS} = 0-6\text{ V}$, $R_{G(on)} = 10\ \Omega$, $R_{G(off)} = 1\ \Omega$, $L = 120\ \mu\text{H}$, $L_P = 10\text{ nH}$ (notes 7, 8) |
| Switching Energy during turn-off | E_{off} | | 14.7 | | μJ | |

(6) See Figure 12 for timing test circuit diagram and definition waveforms.

(7) L_P is the switching circuit parasitic inductance.

(8) See Figure 13 for switching test circuit.

Electrical Performance Graphs

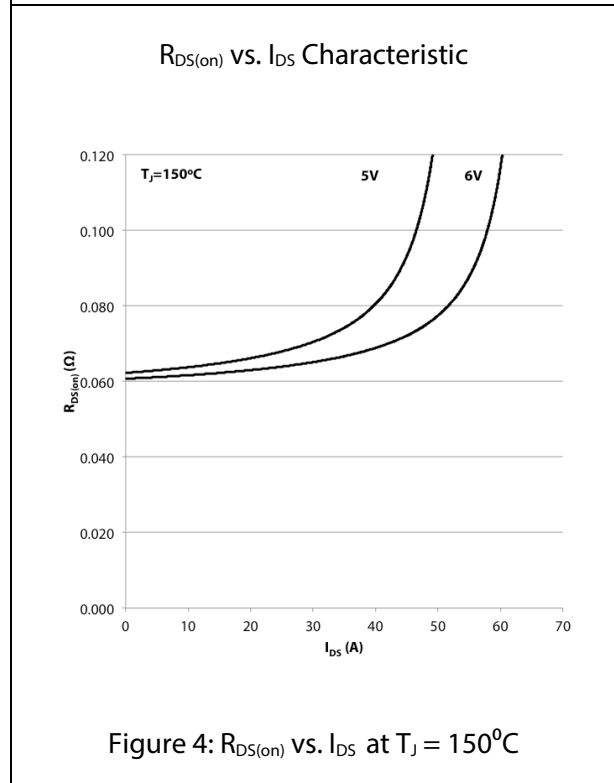
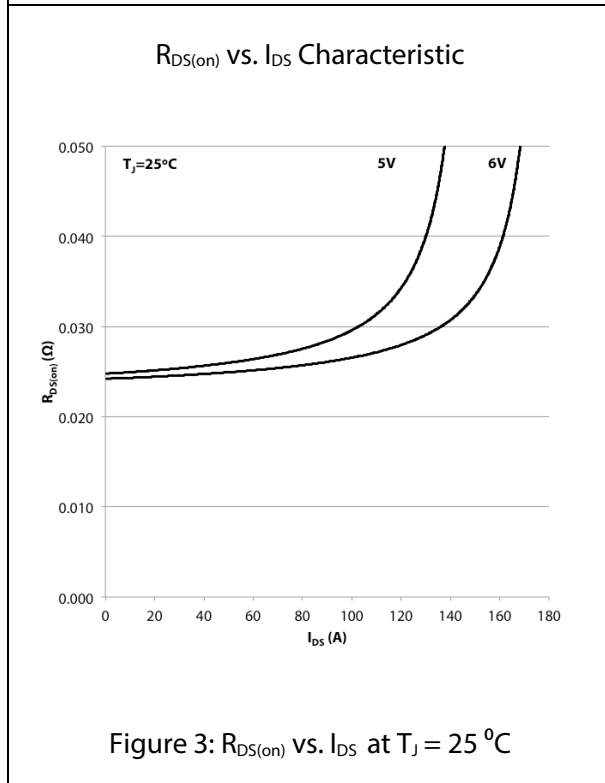
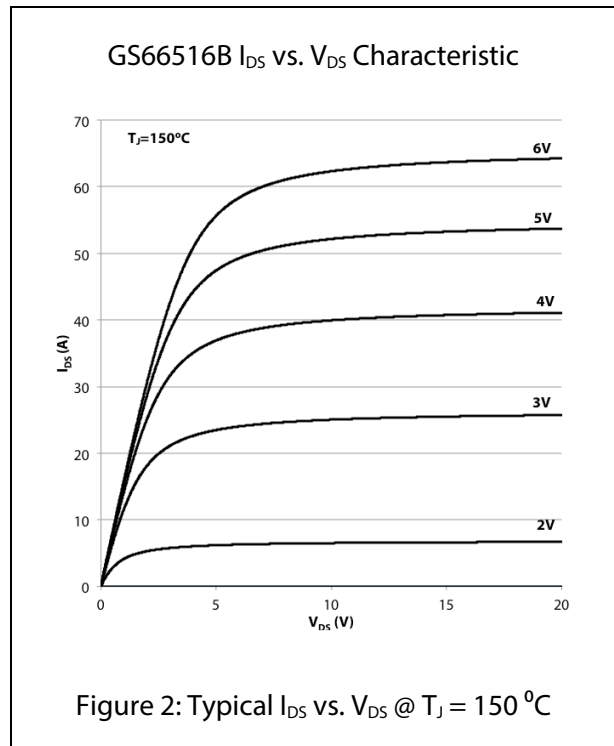
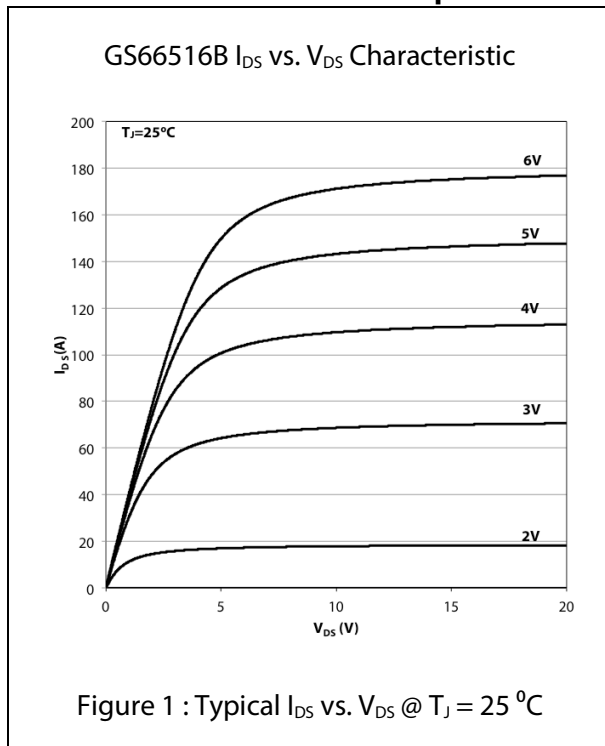

Electrical Performance Graphs

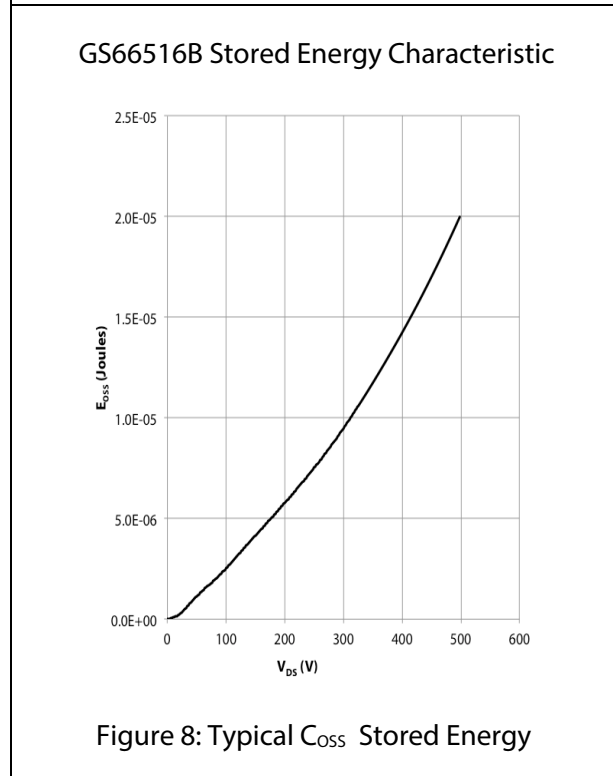
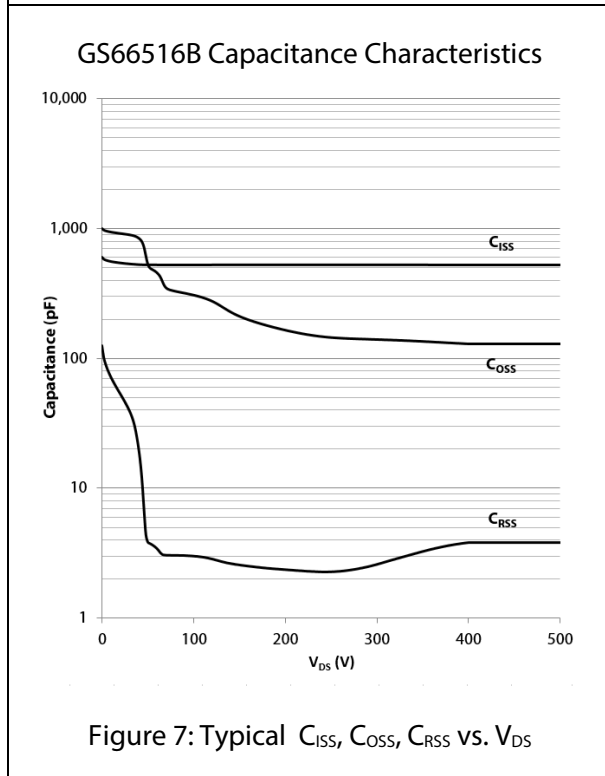
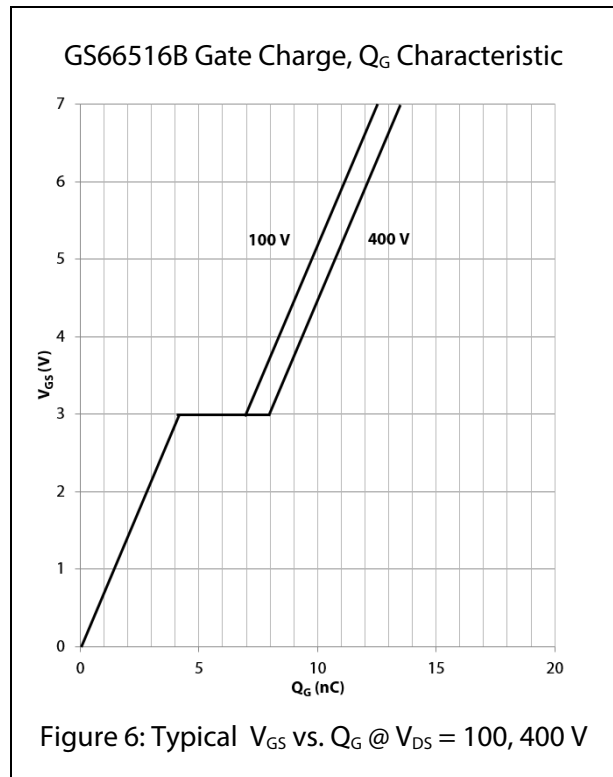
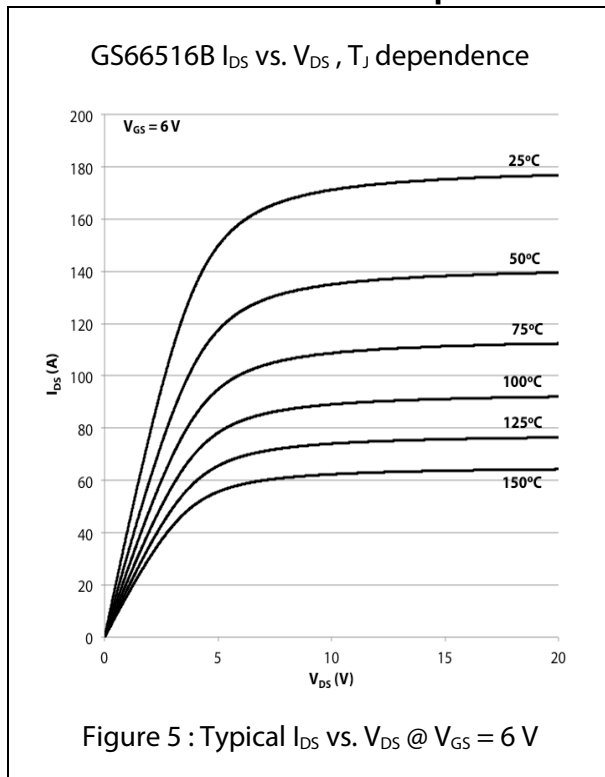

Electrical Performance Graphs

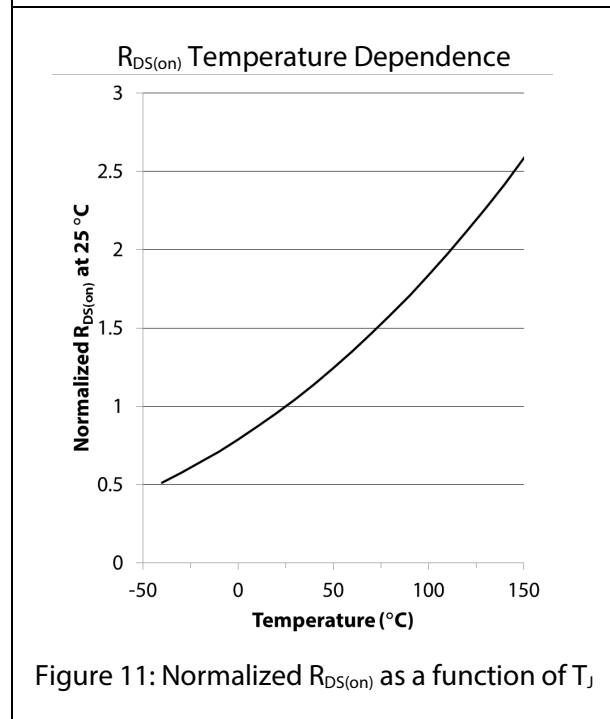
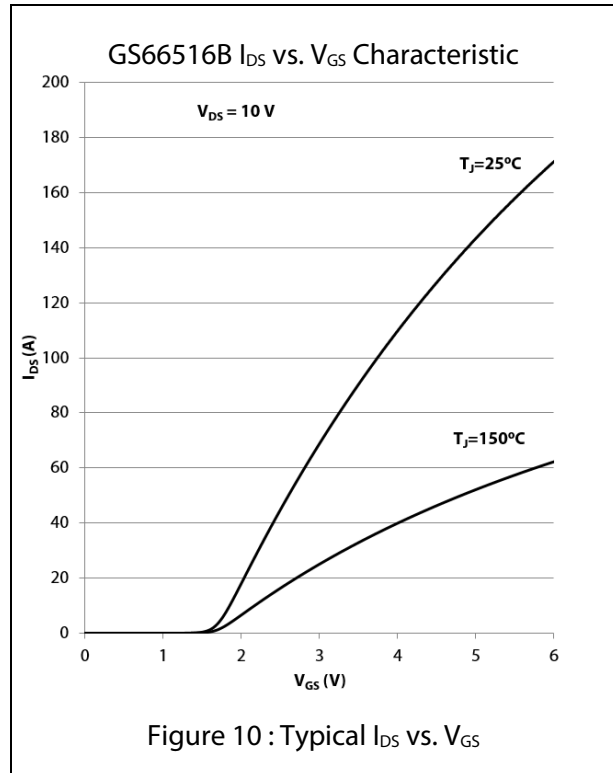
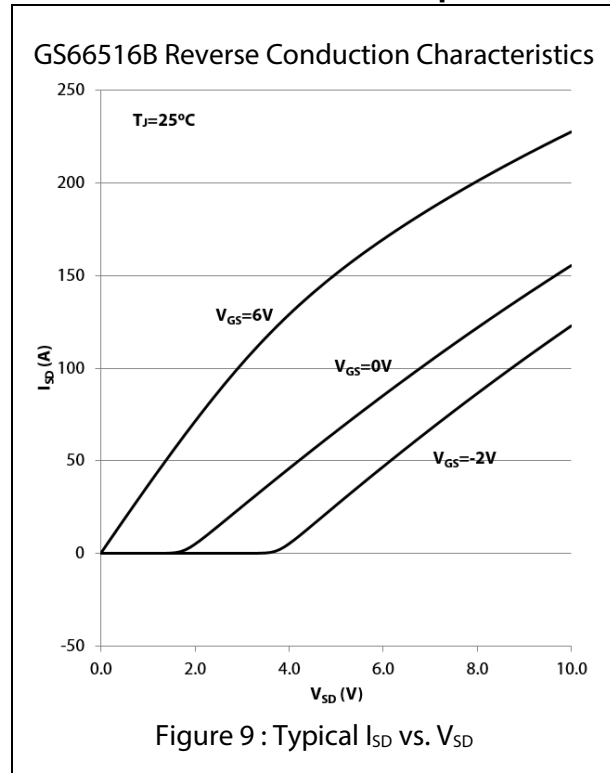

Test Circuits

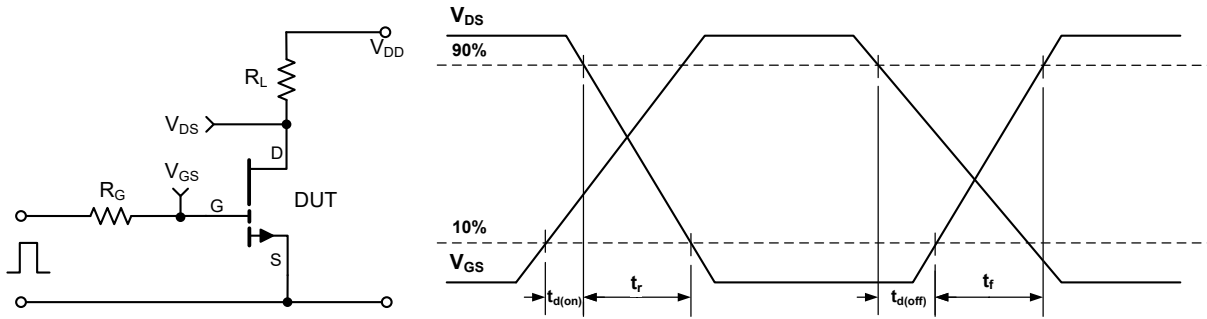

Figure 12: GS66516B switching time test circuit and waveforms

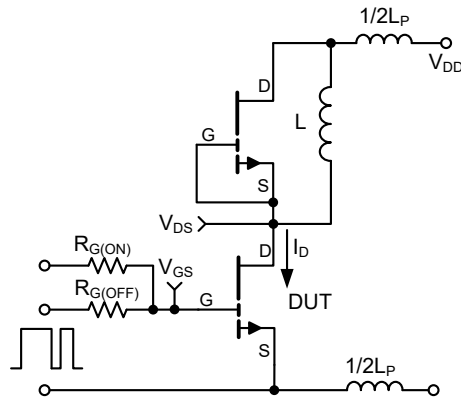

Figure 13: GS66516B Switching Loss Test Circuit

Thermal Performance Graphs

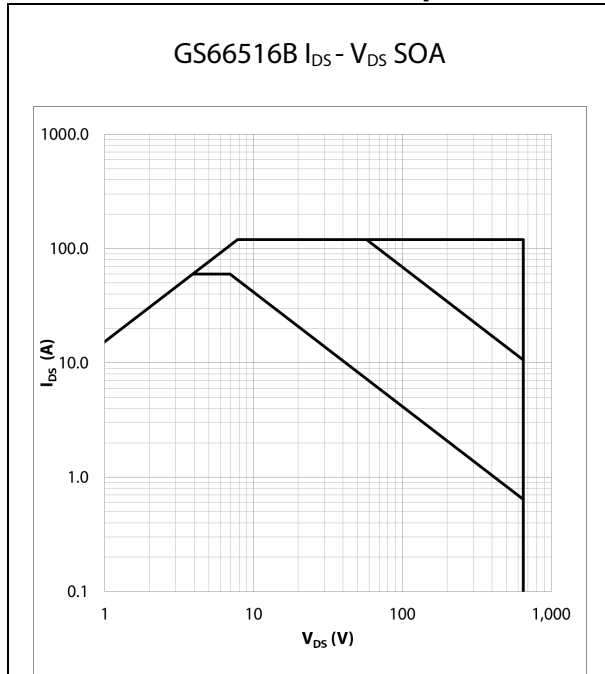

Figure 14: Safe Operating Area @ $T_{case} = 25\text{ }^{\circ}\text{C}$

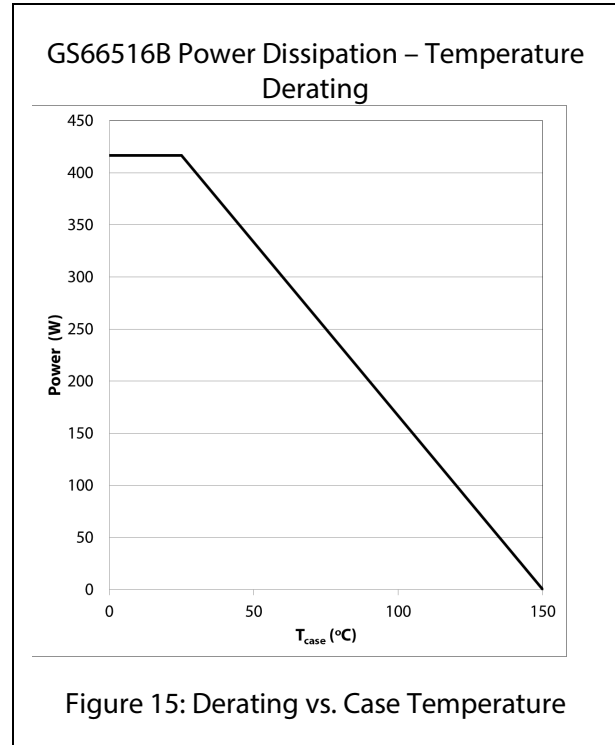

Figure 15: Derating vs. Case Temperature

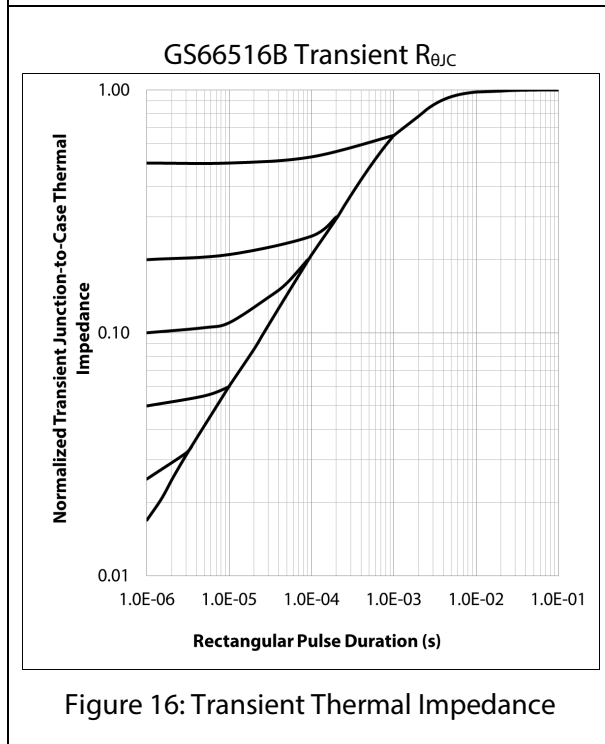

Figure 16: Transient Thermal Impedance

Application Information

Gate Drive

The recommended gate drive voltage is 0 V to + 6 V for optimal $R_{DS(on)}$ performance and long life. The absolute maximum gate to source voltage rating is specified to be +7.0 V maximum DC. The gate drive can survive transients up to +10 V and – 20 V for pulses up to 1 μ s. These specifications allow designers to easily use 6.0 V or even 6.5 V gate drive settings. At 6 V gate drive voltage the enhancement mode high electron mobility transistor (E-HEMT) is fully enhanced and reaches its optimal efficiency point. A 5 V gate drive can be used but may result in lower operating efficiency. Inherently, GaN Systems E-HEMT do not require negative gate bias to turn off. Negative gate bias ensures safe operation against the voltage spike on the gate, however it increases the reverse conduction loss. For more details, please refer to the gate driver application note GN001, Application Guide – Design with GaN Enhancement Mode HEMT” at www.gansystems.com.

Similar to a silicon MOSFET, an external gate resistor can be used to control the switching speed and slew rate. Adjusting the resistor to achieve the desired slew rate may be needed. Lower turn-off gate resistance, $R_{G(OFF)}$ is recommended for better immunity to cross conduction. Please see the gate driver application note (GN001) for more details.

A standard MOSFET driver can be used as long as it supports 6 V for gate drive and the UVLO is suitable for 6 V operation. Gate drivers with low impedance and high peak current are recommended for fast switching speed. GaN Systems E-HEMTs have significantly lower Q_G when compared to equally sized $R_{DS(on)}$ MOSFETs, so high speed can be reached with smaller and lower cost gate drivers.

Some non-isolated half bridge MOSFET drivers are not compatible with 6 V gate drive due to their high under-voltage lockout threshold. Also, a simple bootstrap method for high side gate drive may not be able to provide tight enough tolerance on the gate voltage. Therefore special care should be taken when you select and use half bridge drivers. Please see the gate driver application note, GN001, for more details.

Parallel Operation

Design wide tracks or polygons on the PCB to distribute the gate drive signals to multiple devices. Keep the drive loop length to each device as short and equal length as possible.

GaN enhancement mode HEMTs have a positive temperature coefficient on-state resistance which helps to balance the current. However, special care should be taken in the driver circuit and PCB layout since the device switches at very high speed. It is recommended to have a symmetric PCB layout and equal gate drive loop length (star connection if possible) on all parallel devices to ensure balanced dynamic current sharing. Adding a small gate resistor (1-2 Ω) on each gate is strongly recommended to minimize the gate’s parasitic oscillation.

Source Sensing

The GS66516B has two dedicated source sense pads. The GaN^{PX}® packaging utilizes no wire bonds so the source connection is very low inductance. The dedicated source sense pin will further enhance performance by eliminating the common source inductance if a dedicated gate drive signal kelvin connection is created. This can be achieved by connecting the gate drive signal from the driver to the gate pad on the GS66516B and returning from the source sense pad on the GS66516B to the driver ground reference.

Thermal

The substrate is internally connected to the source/thermal pad on the bottom-side of the GS66516B. The transistor is designed to be cooled using the printed circuit board. The Drain pad is not as thermally conductive as the thermal pad. However adding more copper under this pad will improve thermal performance by reducing the package temperature.

Reverse Conduction

GaN Systems enhancement mode HEMTs do not have an intrinsic body diode and there is zero reverse recovery charge. The devices are naturally capable of reverse conduction and exhibit different characteristics depending on the gate voltage. Anti-parallel diodes are not required for GaN Systems transistors as is the case for IGBTs to achieve reverse conduction performance.

On-state condition ($V_{GS} = +6\text{ V}$): The reverse conduction characteristics of a GaN Systems enhancement mode HEMT in the on-state is similar to that of a silicon MOSFET, with the I-V curve symmetrical about the origin and exhibits a channel resistance, $R_{DS(on)}$, similar to forward conduction operation.

Off-state condition ($V_{GS} \leq 0\text{ V}$): The reverse characteristics in the off-state are different from silicon MOSFETs as the GaN device has no body diode. In the reverse direction, the device starts to conduct when the gate voltage, with respect to the drain, V_{GD} , exceeds the gate threshold voltage. At this point the device exhibits a channel resistance. This condition can be modeled as a “body diode” with slightly higher V_F and no reverse recovery charge.

If negative gate voltage is used in the off-state, the source-drain voltage must be higher than $V_{GS(th)} + V_{GS(off)}$ in order to turn the device on. Therefore, a negative gate voltage will add to the reverse voltage drop “ V_F ” and hence increase the reverse conduction loss.

Blocking Voltage

The blocking voltage rating, BV_{DS} , is defined by the drain leakage current. The hard (unrecoverable) breakdown voltage is approximately 30 % higher than the rated BV_{DS} . As a general practice, the maximum drain voltage should be de-rated in a similar manner as IGBTs or silicon MOSFETs. All GaN E-HEMTs do not avalanche and thus do not have an avalanche breakdown rating. The maximum drain-to-source rating is 650 V and doesn't change with negative gate voltage. A transient drain-to-source voltage of 750 V for 1 μs is acceptable.

Packaging and Soldering

The package material is high temperature epoxy-based PCB material which is similar to FR4 but has a higher temperature rating, thus allowing the GS66516B device to be specified to 150 °C. The device can handle at least 3 reflow cycles.

It is recommended to use the reflow profile in IPC/JEDEC J-STD-020 REV D.1 (March 2008)

The basic temperature profiles for Pb-free (Sn-Ag-Cu) assembly are:

- Preheat/Soak: 60 - 120 seconds. $T_{min} = 150\text{ °C}$, $T_{max} = 200\text{ °C}$.
- Reflow: Ramp up rate 3 °C/sec, max. Peak temperature is 260 °C and time within 5 °C of peak temperature is 30 seconds.
- Cool down: Ramp down rate 6 °C/sec max.

Using “Non-Clean” soldering paste and operating at high temperatures may cause a reactivation of the “Non-Clean” flux residues. In extreme conditions unwanted conduction paths may be created. Therefore, when the product operates at greater than 100 °C it is recommended to also clean the “Non-Clean” paste residues.

Package Dimensions

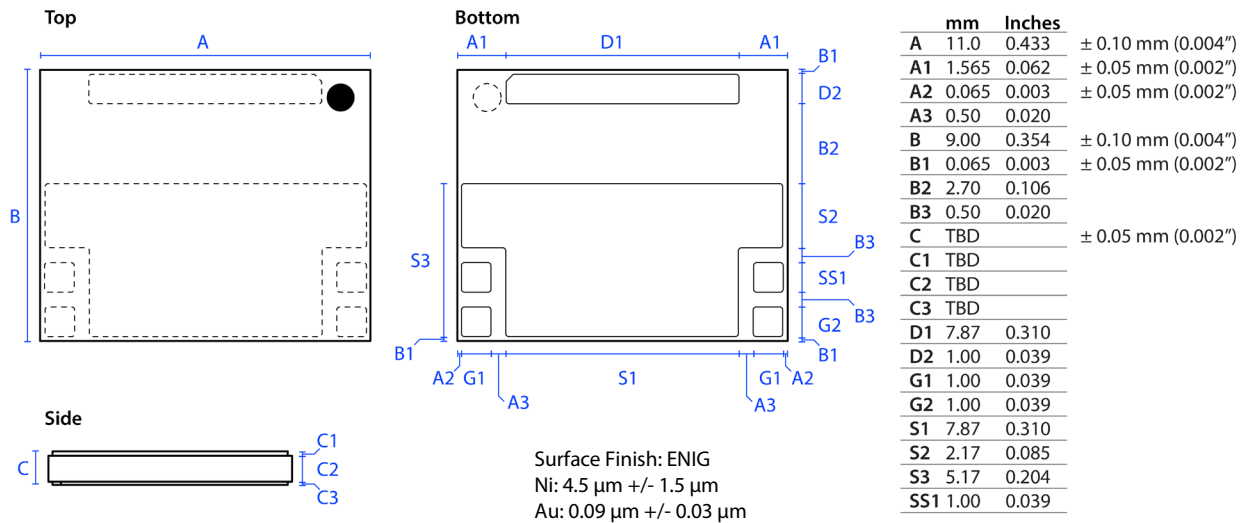

Note: Inch measurements are approximate values

Recommended Minimum Footprint for Printed Circuit Board

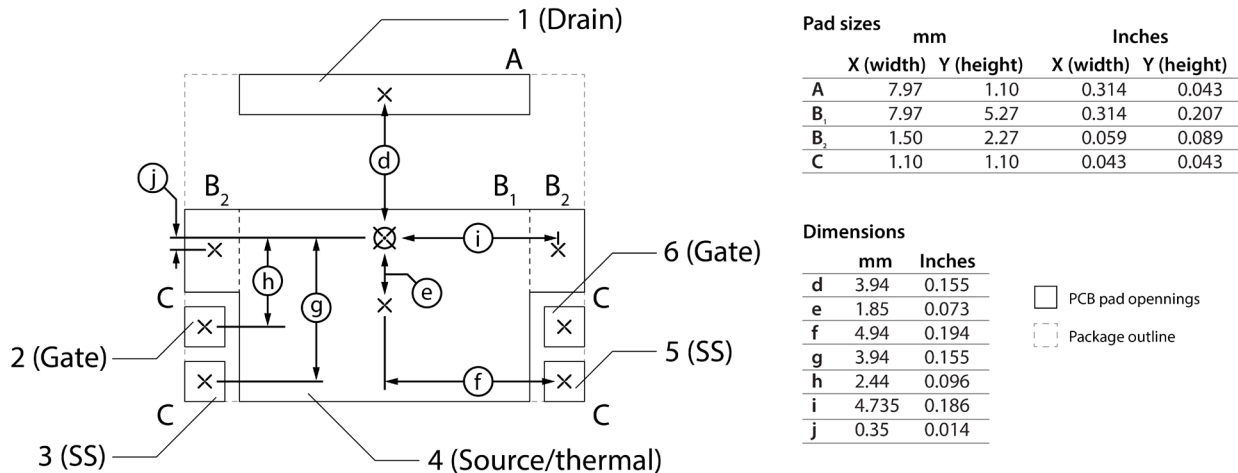

Important Notice – Unless expressly approved in writing by an authorized representative of GaN Systems, GaN Systems components are not designed, authorized or warranted for use in lifesaving, life sustaining, military, aircraft, or space applications, nor in products or systems where failure or malfunction may result in personal injury, death, or property or environmental damage. The information given in this document shall not in any event be regarded as a guarantee of performance. GaN Systems hereby disclaims any or all warranties and liabilities of any kind, including but not limited to warranties of non-infringement of intellectual property rights. All other brand and product names are trademarks or registered trademarks of their respective owners. Information provided herein is intended as a guide only and is subject to change without notice. The information contained herein or any use of such information does not grant, explicitly, or implicitly, to any party any patent rights, licenses, or any other intellectual property rights. GaN Systems standard terms and conditions apply. All rights reserved.

Mouser Electronics

Authorized Distributor

Click to View Pricing, Inventory, Delivery & Lifecycle Information:

GaN Systems:

[GS66516T-E01-TY](#) [GS66516T-E02-TY](#) [GS66516T-E02-MR](#) [GS66516B-E01-MR](#)